

# Combo No.8 | FLFF 272mm

SKU: FDCU\_13-23\_L1H1\_C8\_FF272

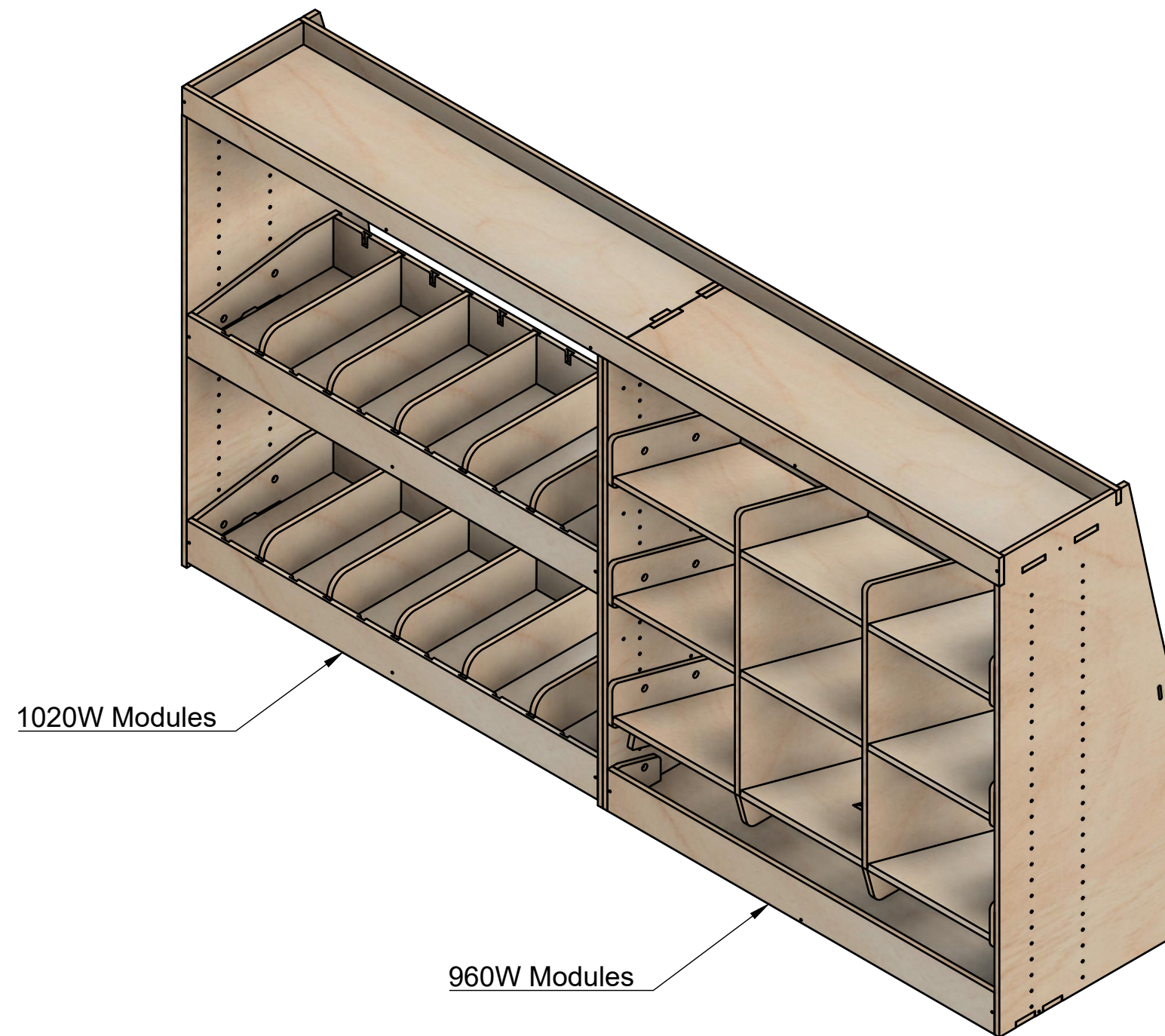

## Page 1 - Overview

All units in mm

Plywood thickness = 12mm

### Notes

- The spacing of the euro container bays is set. Other modules can be adjusted.
- Each section of rack can accept other modules with the same width.
- All organiser dividers are removable.
- This is a Combo No.8 layout that has been adjusted to be paired with one of our full length false floors with 272mm total height.

**YOKE VANS**  
info@yoke-van-kits.co.uk  
0208 132 9221

© 2023 Yoke CNC LTD

# Combo No.8 | FLFF 272mm

SKU: FDCU\_13-23\_L1H1\_C8\_FF272

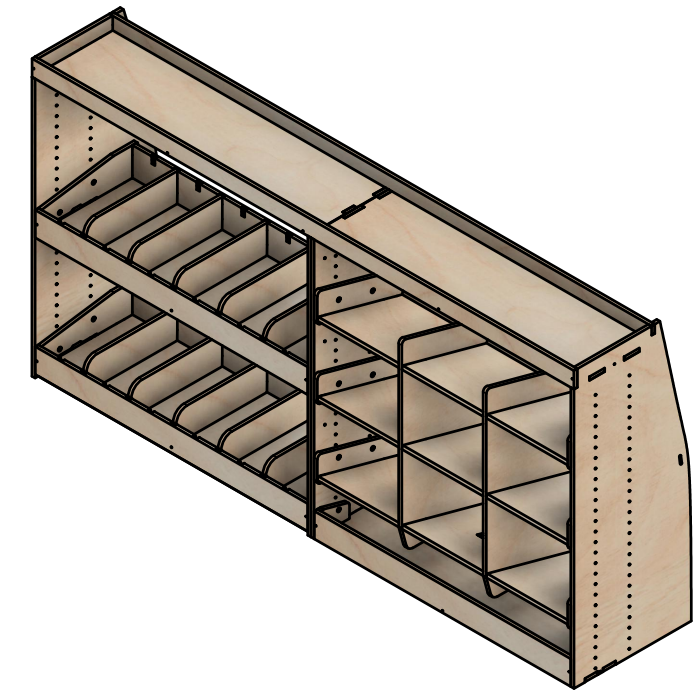
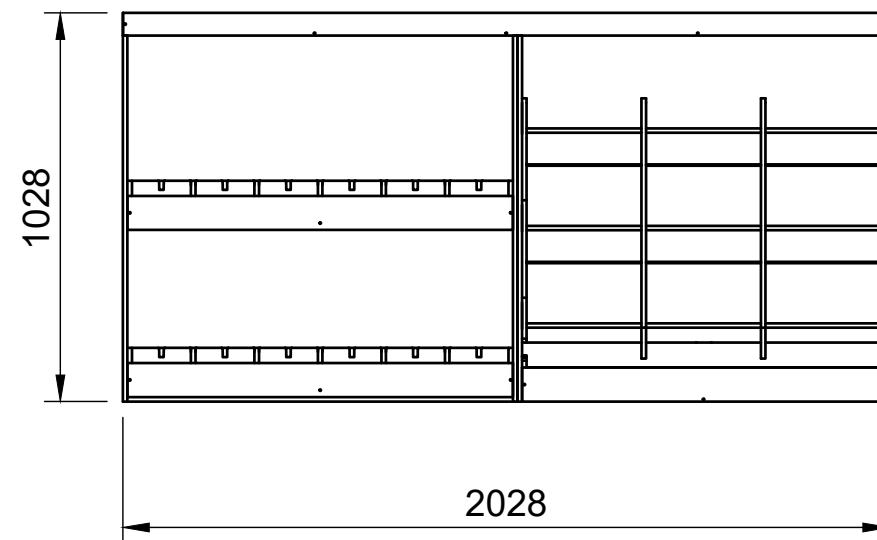
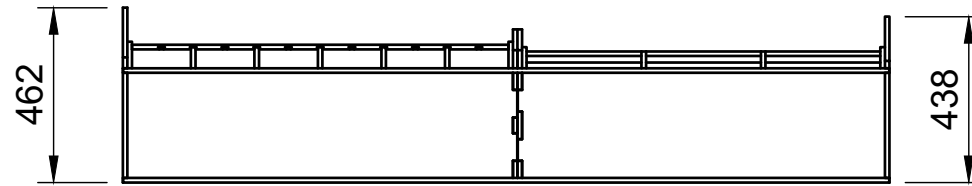

## Page 2 - External Dimensions

All units in mm

Plywood thickness = 12mm

### Notes

- All dimensions on this page are external.

**YOKE VANS**  
info@yoke-van-kits.co.uk  
0208 132 9221

© 2023 Yoke CNC LTD

# Combo No.8 | FLFF 272mm

SKU: FDCU\_13-23\_L1H1\_C8\_FF272

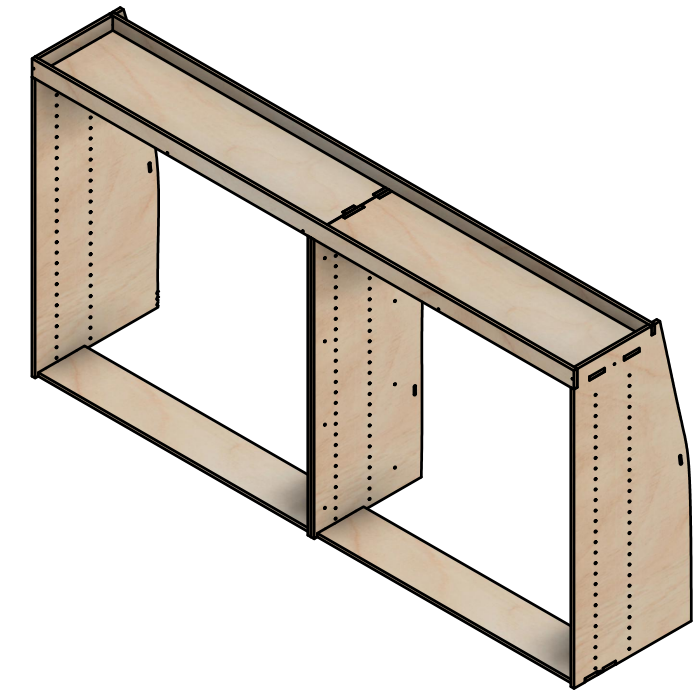
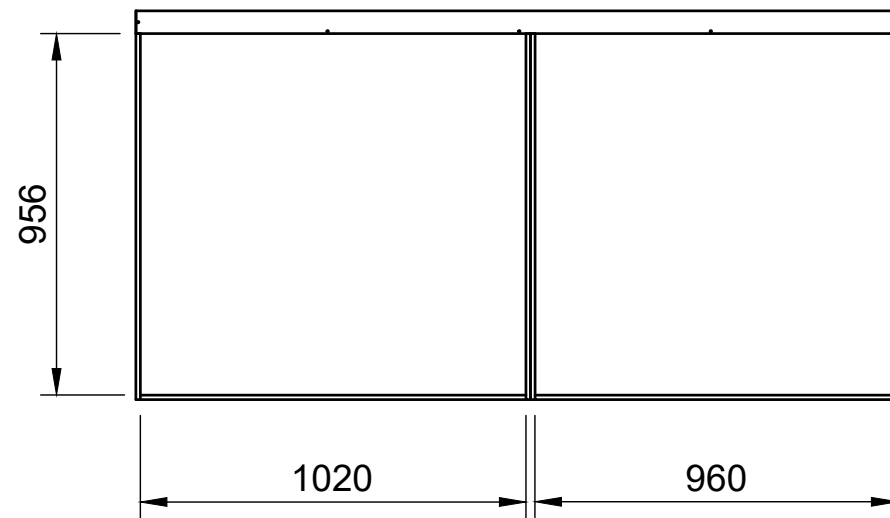
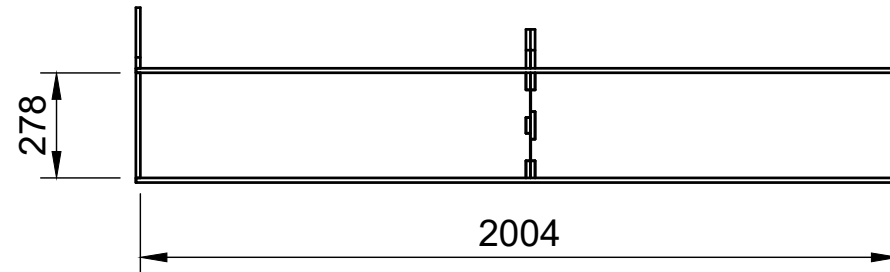

## Page 3 - Internal Dimensions

All units in mm

Plywood thickness = 12mm

### Notes

- All Dimensions on this page are internal.
- Each section of rack can accept other modules with the same width.

**YOKE VANS**

info@yoke-van-kits.co.uk

0208 132 9221

© 2023 Yoke CNC LTD