

Raised Floor No.2A

SKU: FDCU_13_L2H1_FF2A

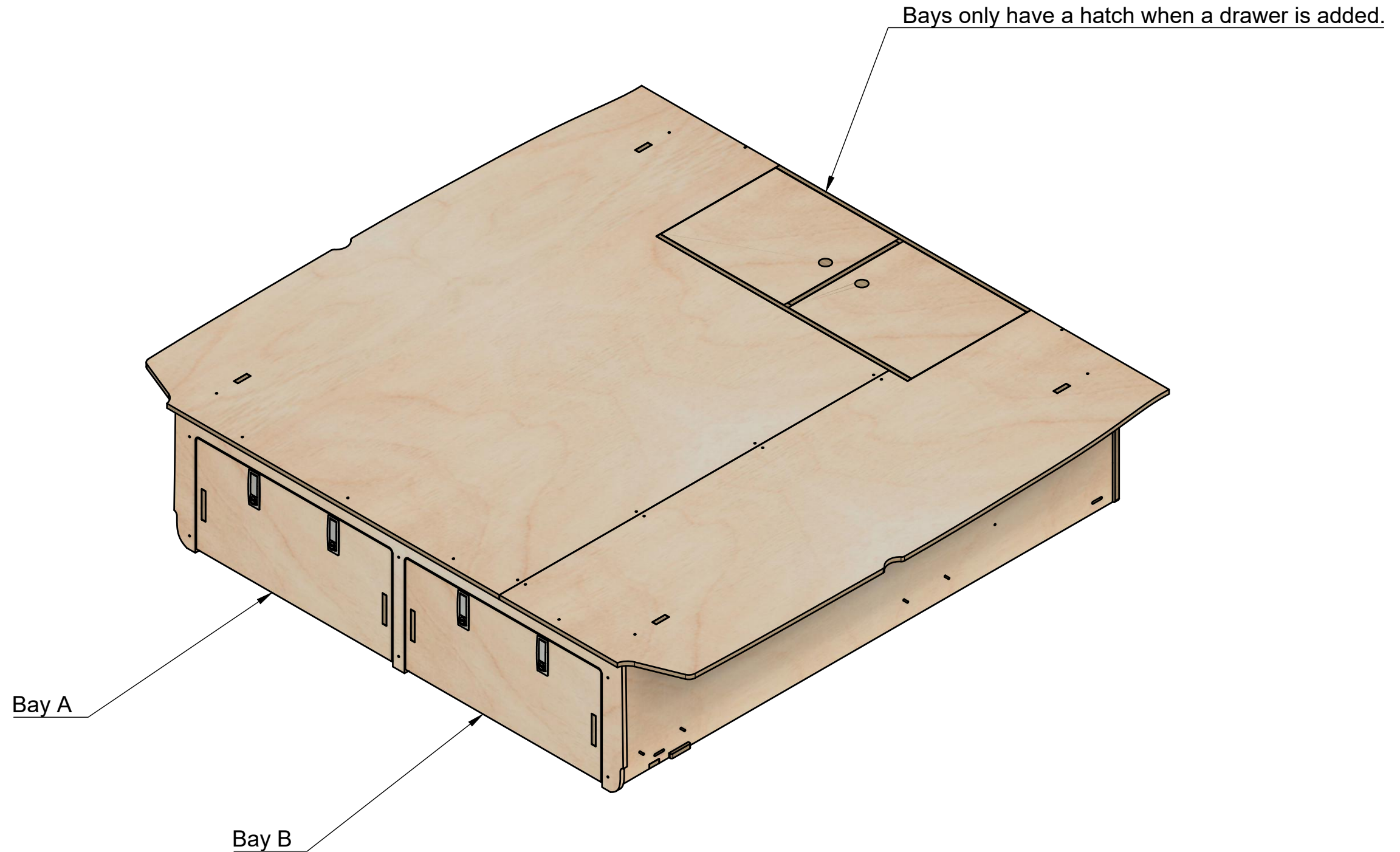

Page 1 - Floor Only

All units in mm

Plywood thickness = 12mm

Notes

- 'Bay A' is open at the rear of floor, with no hatch, when no drawer is added.
- 'Bay B' is always closed at the rear.
- Not designed specifically for metal security vaults.
- Not designed for DCIV or Kombi vehicle models.

YOKE VANS

info@yoke-van-kits.co.uk

0208 132 9221

© 2023 Yoke CNC LTD

Raised Floor No.2A

SKU: FDCU_13_L2H1_FF2A

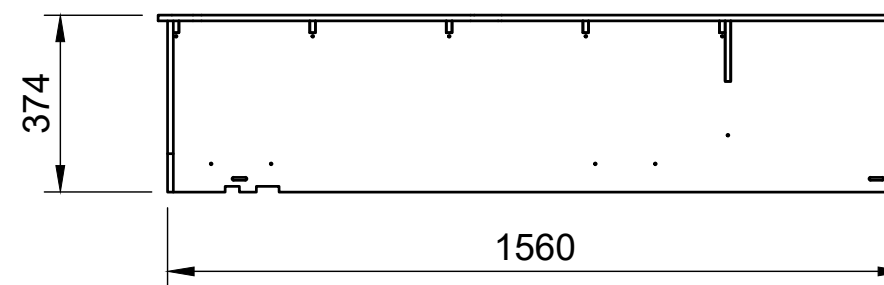
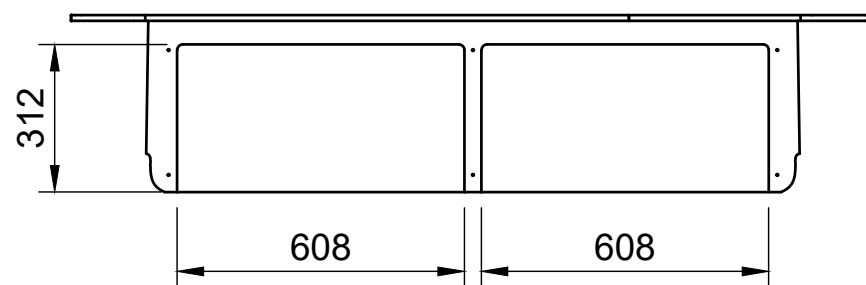
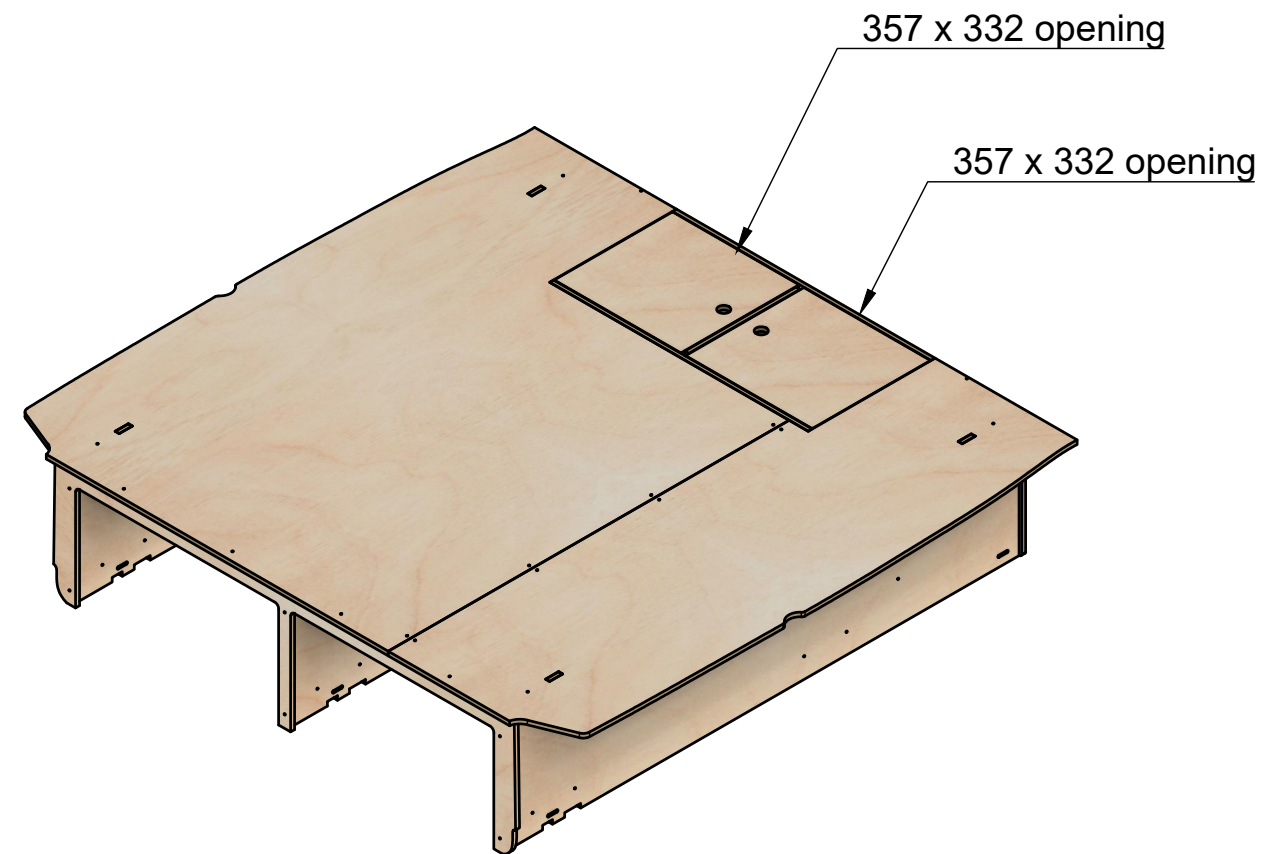

Page 2 - Floor Dimensions

All units in mm

Plywood thickness = 12mm

Notes

- 'Bay A' is open at the rear of floor, with no hatch, when no drawer is added.
- 'Bay B' is always closed at the rear.
- Not designed specifically for metal security vaults.
- Not designed for DCIV or Kombi vehicle models.

YOKE VANS
info@yoke-van-kits.co.uk
0208 132 9221

© 2023 Yoke CNC LTD

Raised Floor No.2A

SKU: FDCU_13_L2H1_FF2A

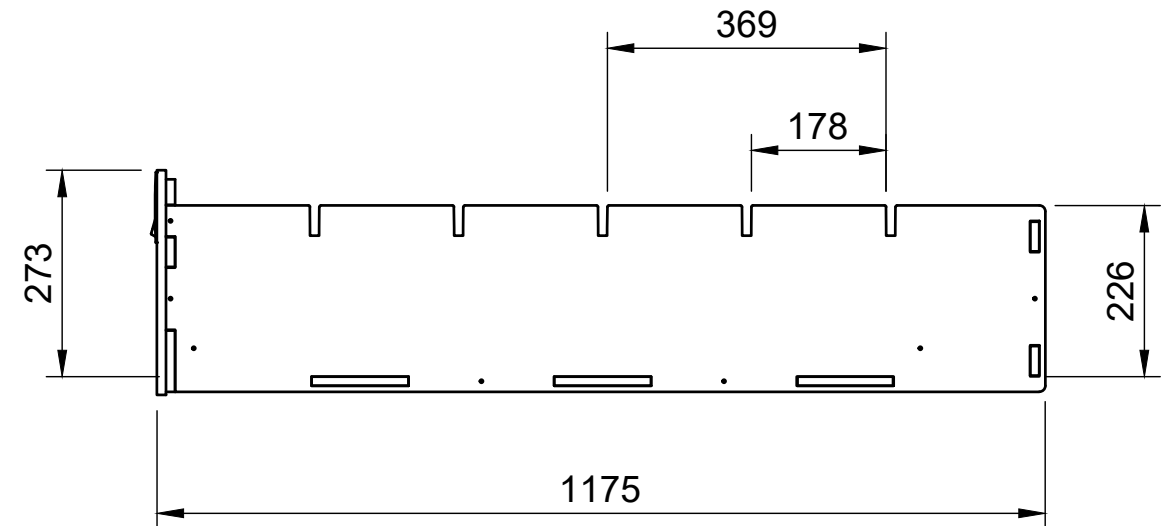
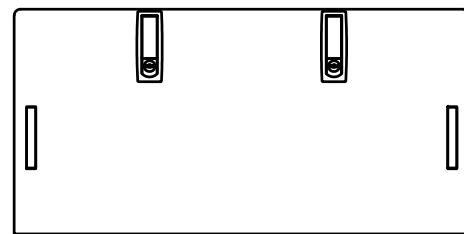
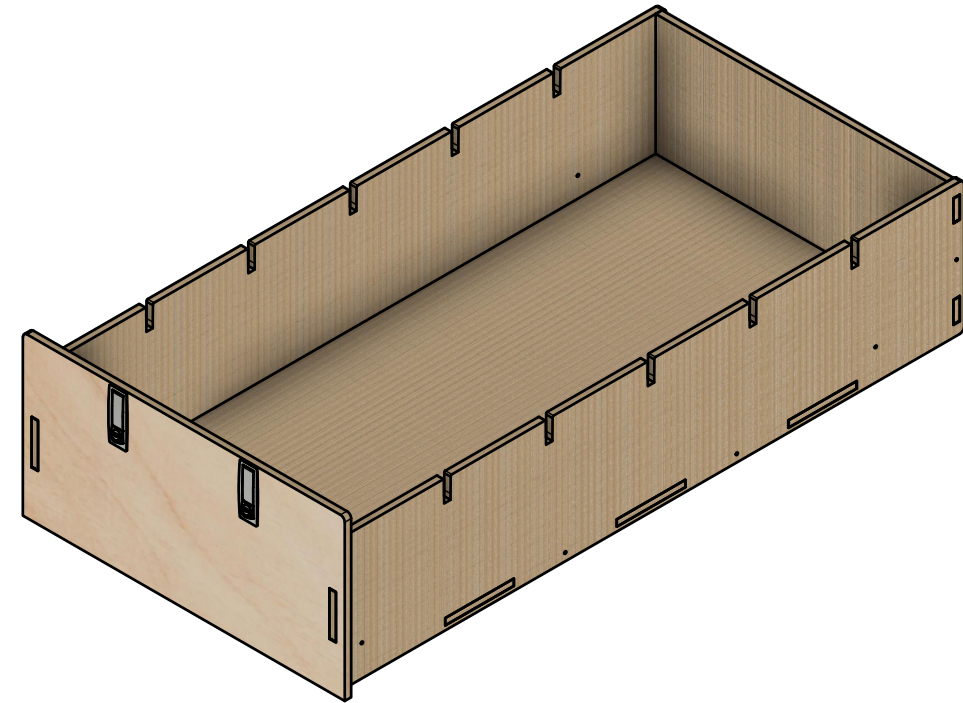
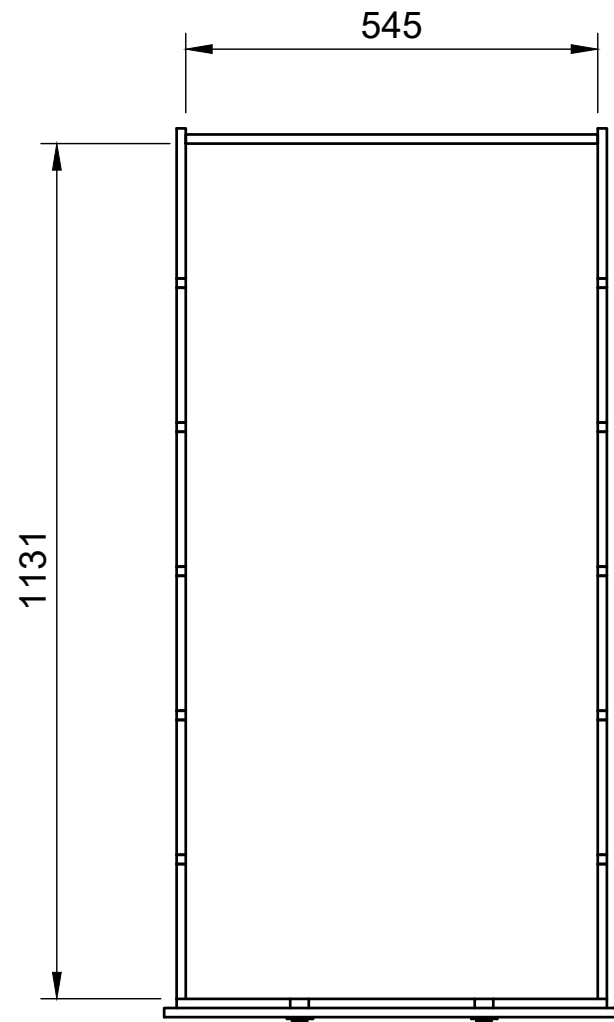

Page 3 - Bay A Drawer Dimensions

All units in mm

Plywood thickness = 12mm

Notes

- Both bays utilize the same size drawers.
- Drawers come with 2 removable dividers as standard.
- Drawers come with a lockable compression latch as standard.
- Drawers are mounted on full extension 1100mm/80kg rated heavy duty runners as standard.

YOKE VANS

info@yoke-van-kits.co.uk

0208 132 9221

© 2023 Yoke CNC LTD

Raised Floor No.2A

SKU: FDCU_13_L2H1_FF2A

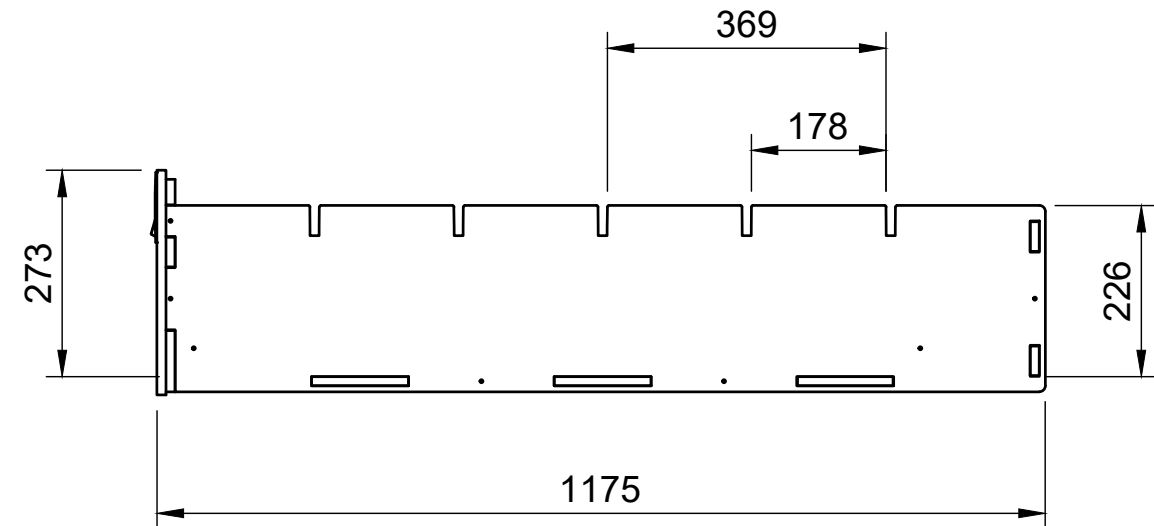
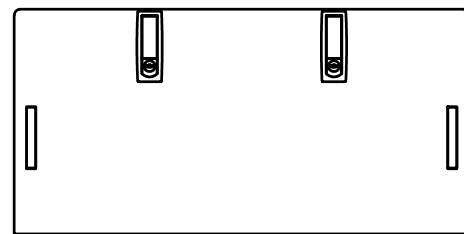
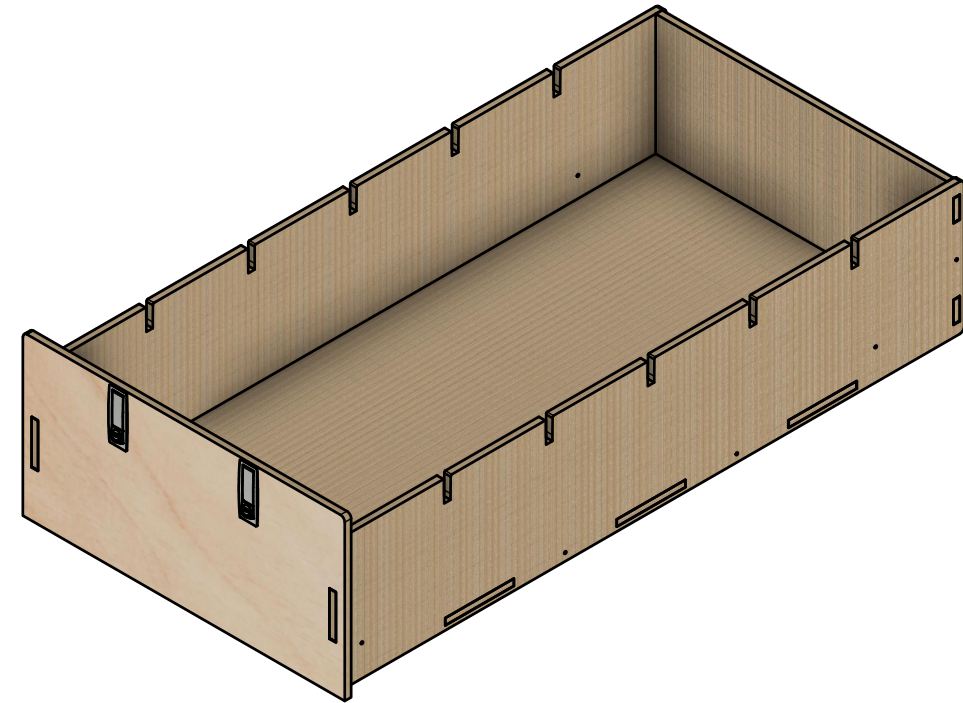
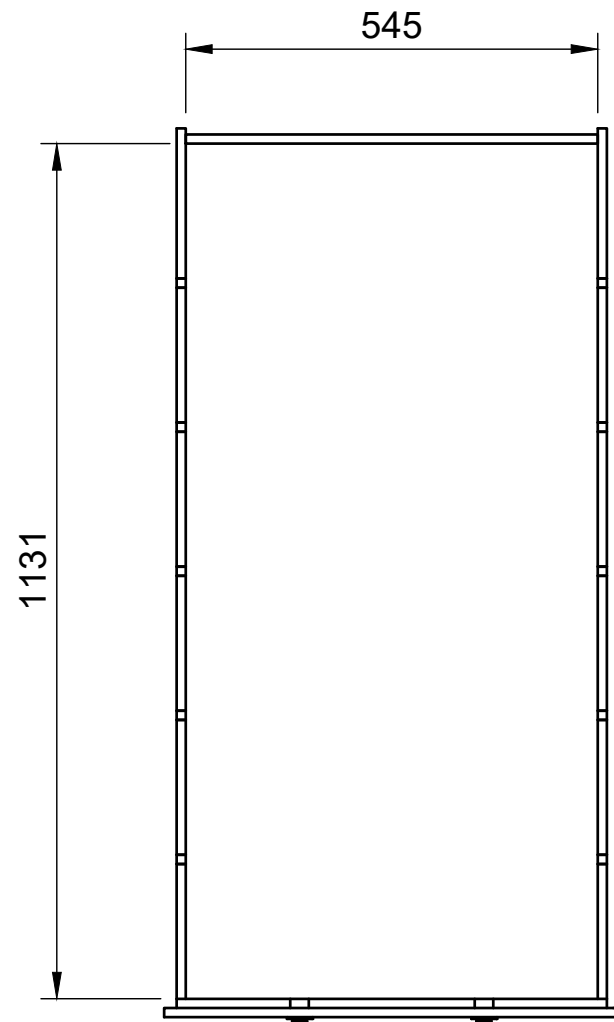

Page 4 - Bay B Drawer Dimensions

All units in mm

Plywood thickness = 12mm

Notes

- Both bays utilize the same size drawers.
- Drawers come with 2 removable dividers as standard.
- Drawers come with a lockable compression latch as standard.
- Drawers are mounted on full extension 1100mm/80kg rated heavy duty runners as standard.

YOKE VANS

info@yoke-van-kits.co.uk

0208 132 9221

© 2023 Yoke CNC LTD