

# Combo No.22 | FF 312

SKU: BP\_18\_L2\_C22\_FF312

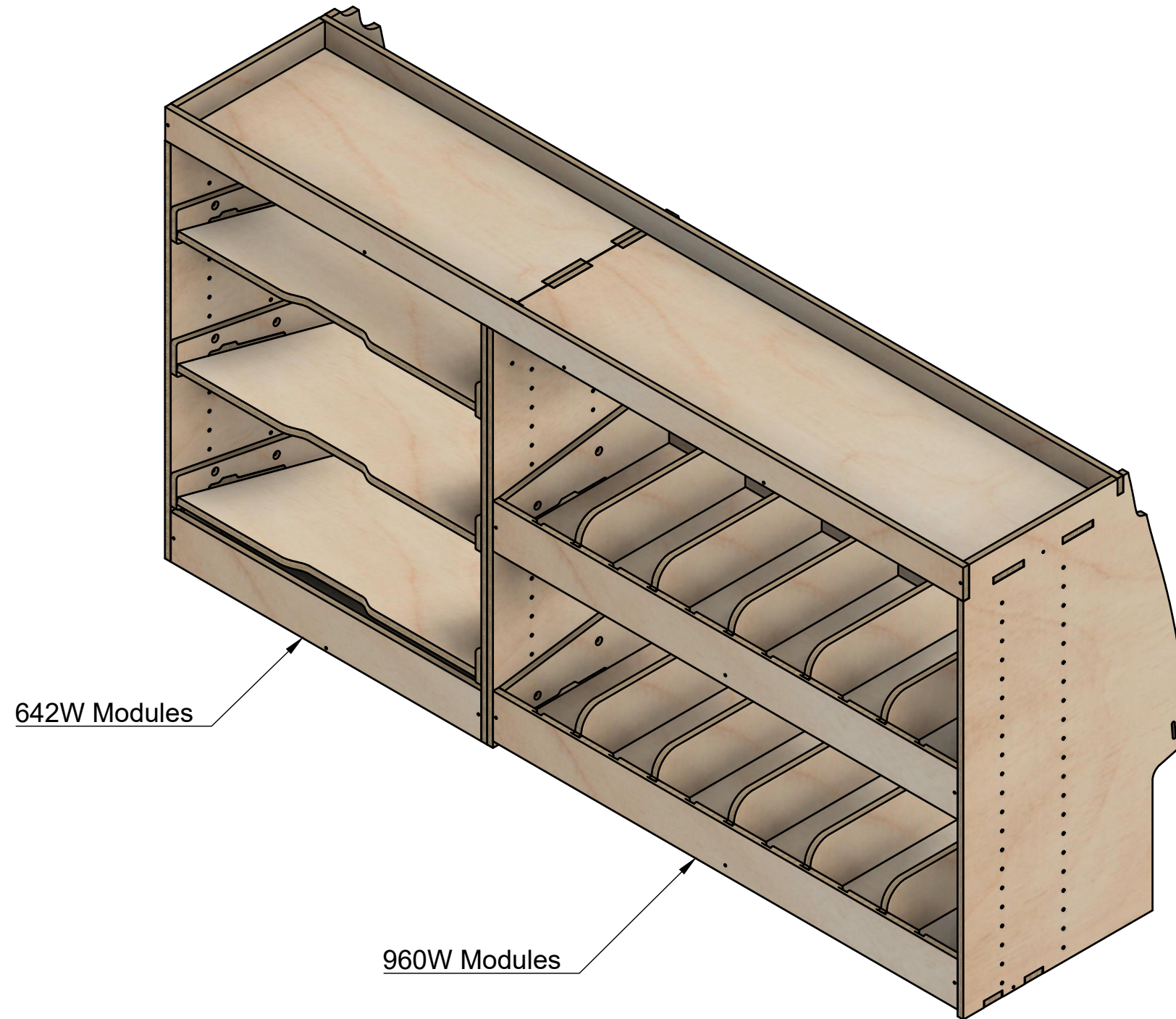

## Page 1 - Overview

All units in mm

Plywood thickness = 12mm

**YOKE VANS**  
info@yoke-van-kits.co.uk  
0208 132 9221

© 2023 Yoke CNC LTD

# Combo No.22 | FF 312

SKU: BP\_18\_L2\_C22\_FF312

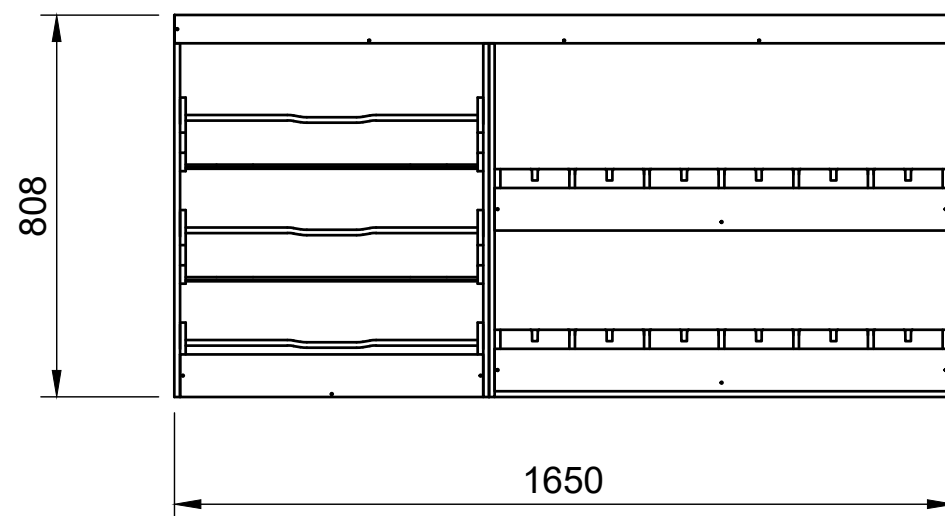
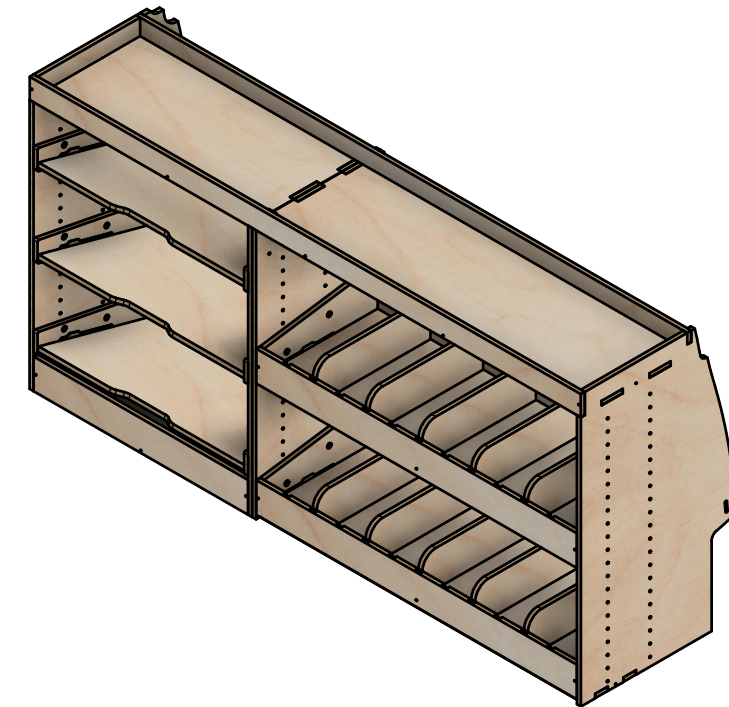
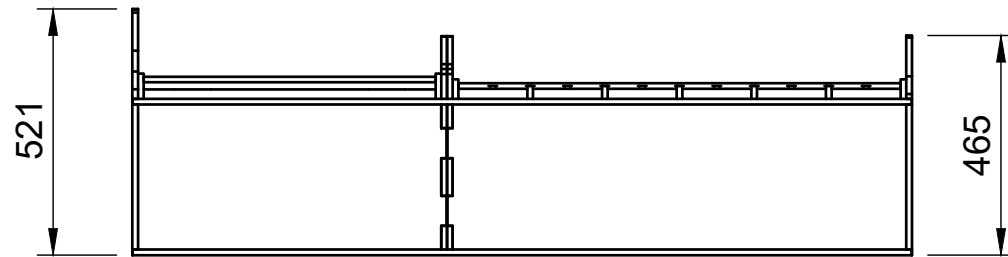

## Page 2 - External Dimensions

All units in mm

Plywood thickness = 12mm

### Notes

- All dimensions on this page are external.

**YOKE VANS**  
info@yoke-van-kits.co.uk  
0208 132 9221

© 2023 Yoke CNC LTD

# Combo No.22 | FF 312

SKU: BP\_18\_L2\_C22\_FF312

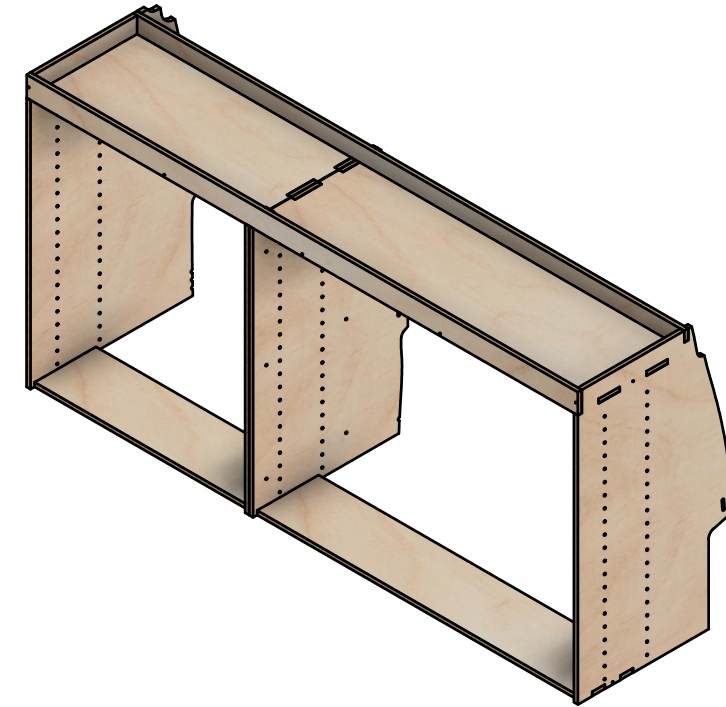
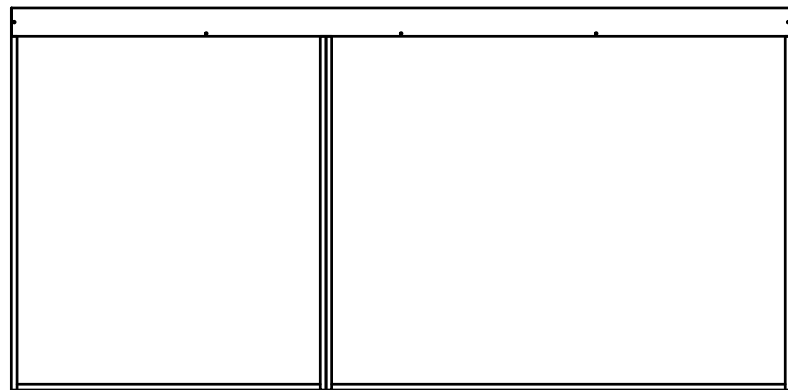
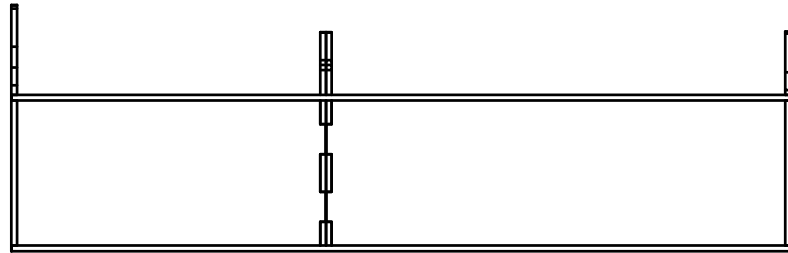

## Page 3 - Internal Dimensions

All units in mm

Plywood thickness = 12mm

### Notes

- All dimensions on this page are internal.

**YOKE VANS**  
info@yoke-van-kits.co.uk  
0208 132 9221

© 2023 Yoke CNC LTD