

Combo No.9

SKU: FDT_14_L2H2_RWD_C1

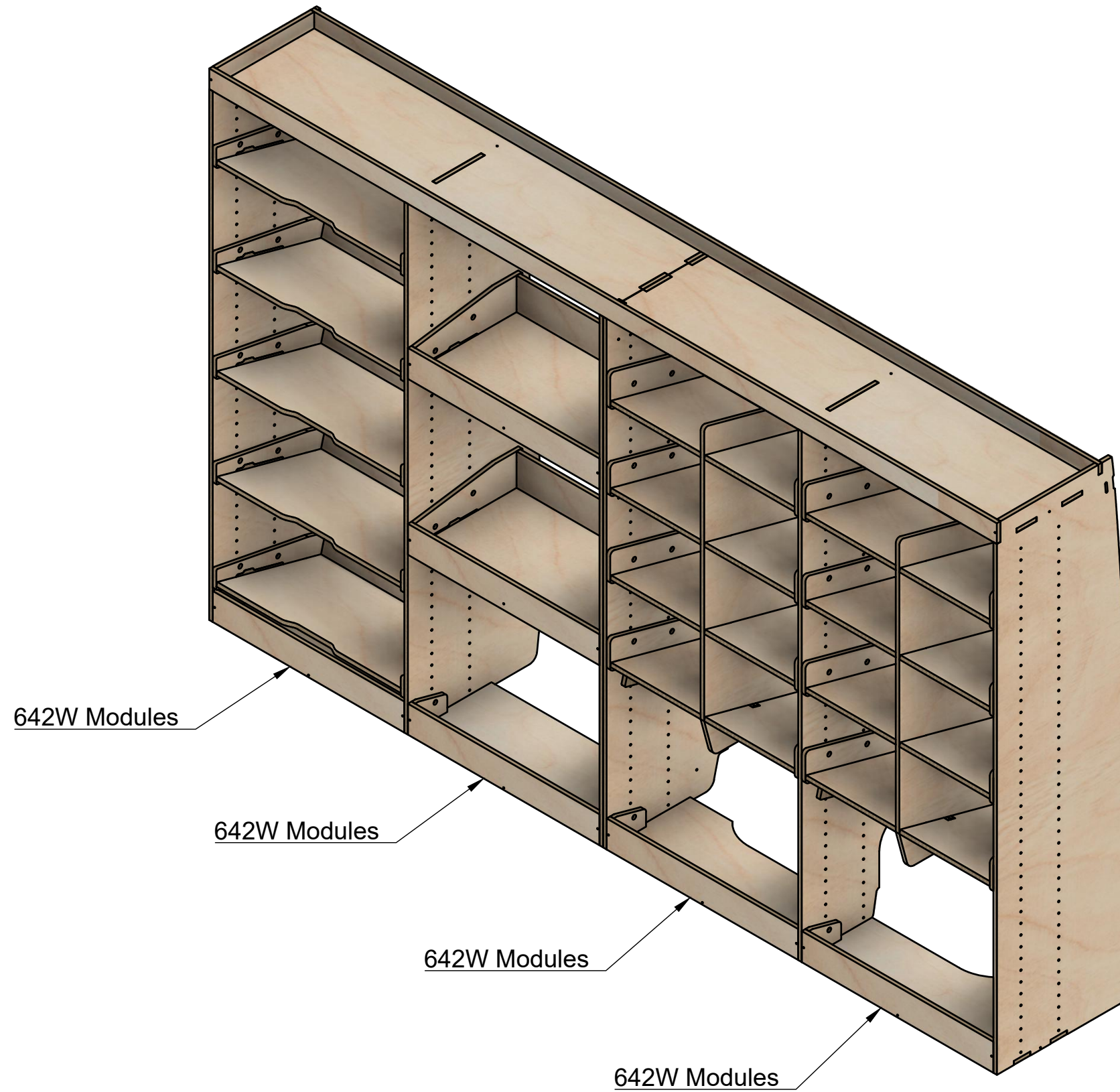

Page 1 - Overview

All units in mm

Plywood thickness = 12mm

YOKE VANS
info@yoke-van-kits.co.uk
0208 132 9221

© 2023 Yoke CNC LTD

Combo No.9

SKU: FDT_14_L2H2_RWD_C1

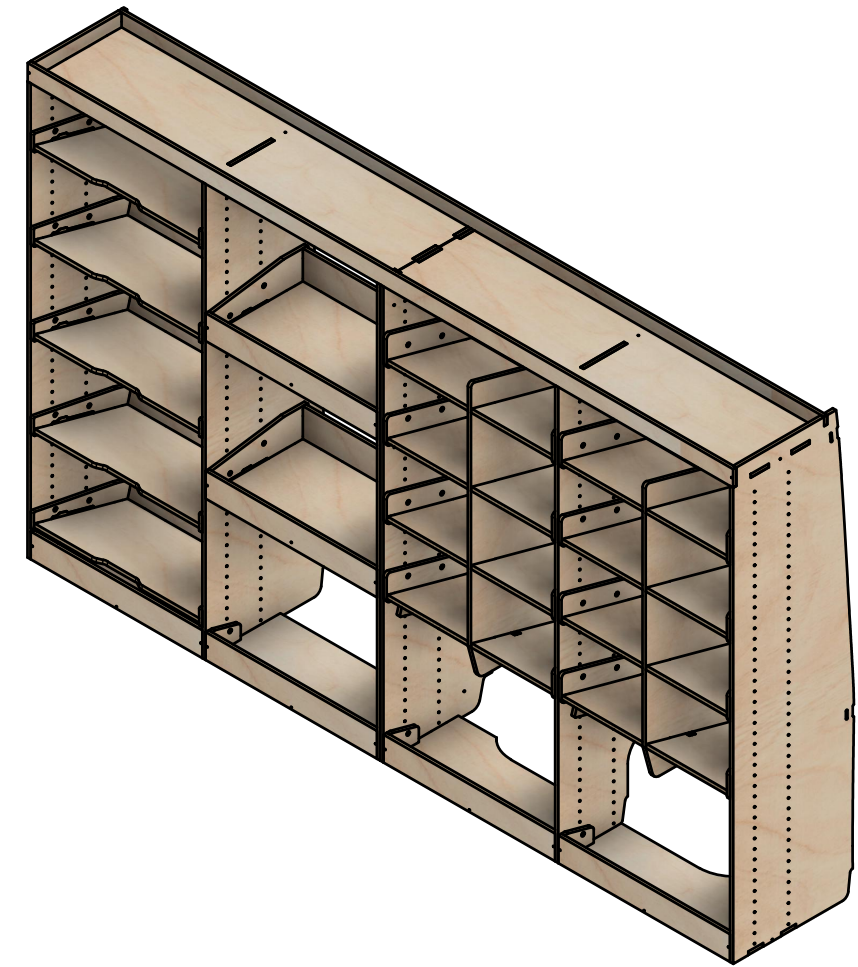
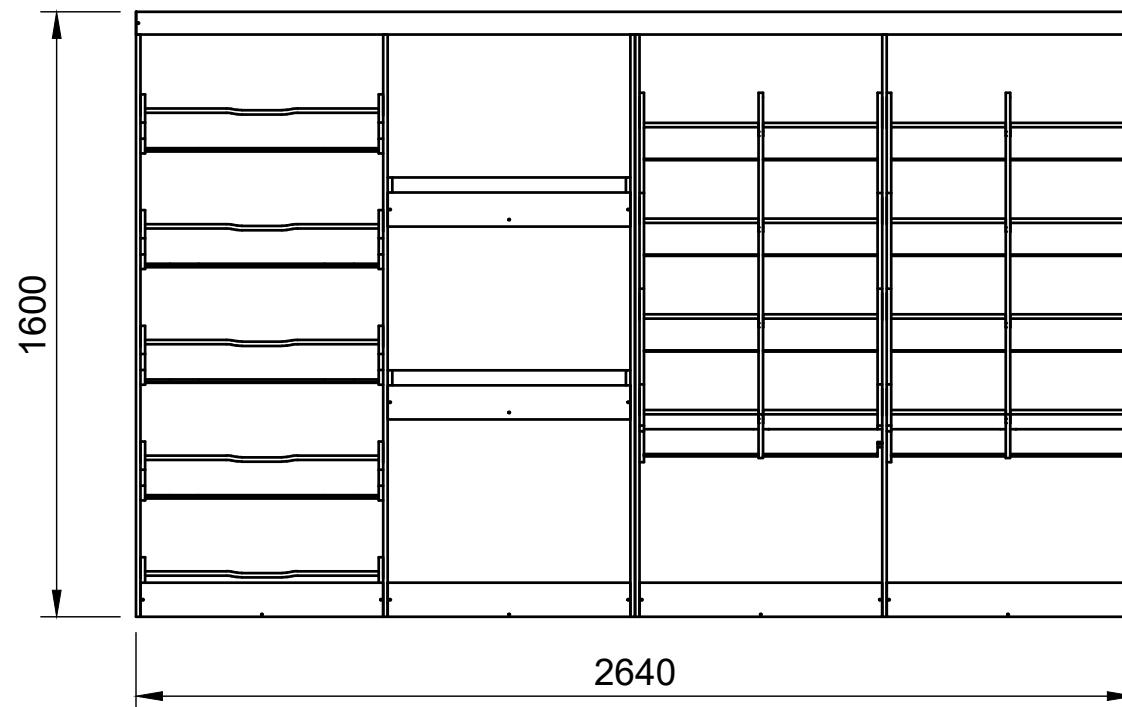
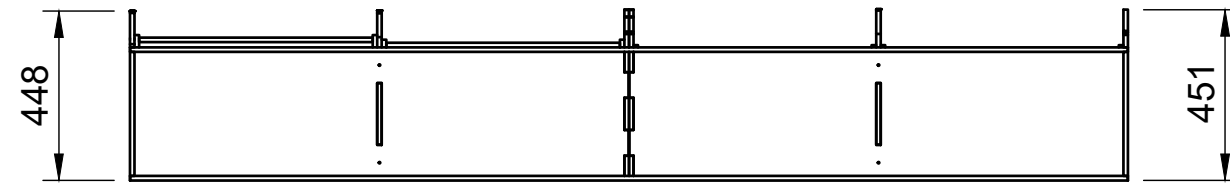

Page 2 - External Dimensions

All units in mm

Plywood thickness = 12mm

Notes

- All dimensions on this page are external.

YOKE VANS

info@yoke-van-kits.co.uk

0208 132 9221

© 2023 Yoke CNC LTD

Combo No.9

SKU: FDT_14_L2H2_RWD_C1

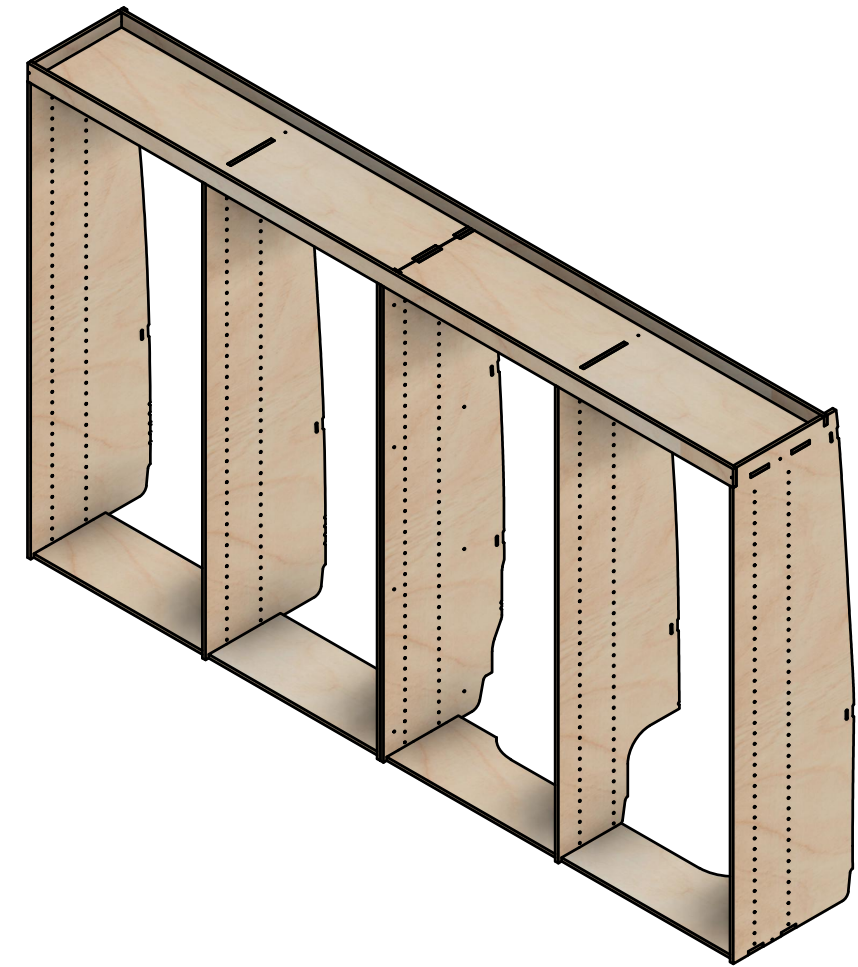
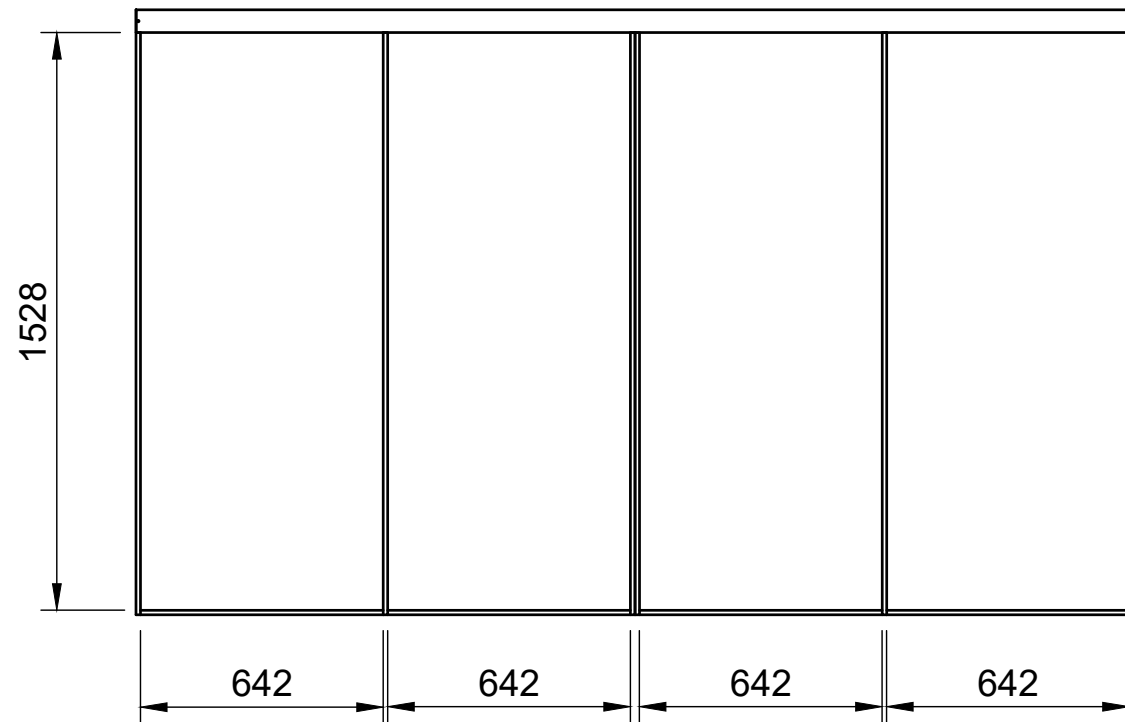
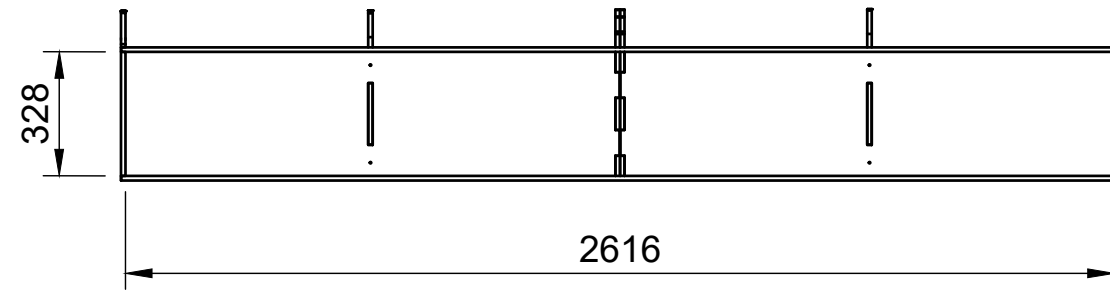

Page 3 - Internal Dimensions

All units in mm

Plywood thickness = 12mm

Notes

- All dimensions on this page are internal.

YOKE VANS
info@yoke-van-kits.co.uk
0208 132 9221

© 2023 Yoke CNC LTD